

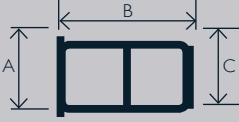

SECTION	EX STOCK	PRODUCT	SIZE			LENGTH	KILO / METRE	PERIMETER	ALLOY
			A	B	C				
90021	✓	Chassis Rail 	106.0	179.0	90.0	4.8m 5.4m	9.624	555.7	6005A/ T5
90028	✓	Chassis Rail 	150.0	230.0	111.0	7.4m	15.307		6005A/ T5
90347	✓	Coaming 	82.2	215.55	118.0	5.4m 7.3m	7.298		6351/T5
90215	*	Coving 	273.0	178.0		5.4m 7.3m	8.63		6351/T5
90302	✓	Cant Rail 	133.35	131.0		6.0m	2.174		6060/T5
90303	✓	Cant & Drip 	136.0	135.0		6.0m	2.317	537.1	6060/T5
90002	✓	Ramp Frame 	150.0	75.0	6.00/3.0	5.0m	4.255	523.2	6082 /T6
90322	✓	Huck Rail 	100.0	4.0		6.0m	1.232		6061/T5
60021	*	Transport Frame 	125.1	174.69			3.252	440.0	6060/T5

A = Width B = Height T = Thickness R = External Radii C = N/A  
 \* Mill runs only, please ask regarding the availability of these  
 # Other stock lengths available in this size. If the product you require is not listed please enquire

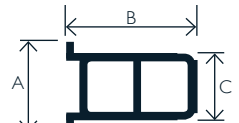
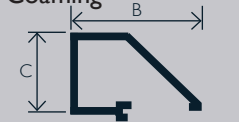
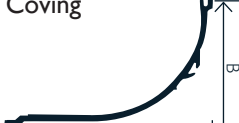
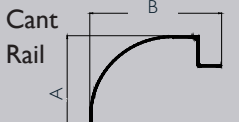
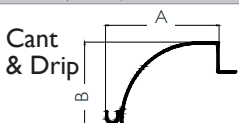
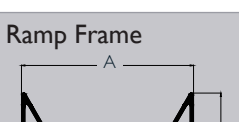
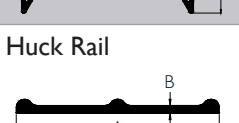
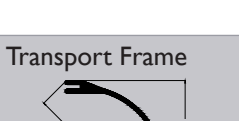
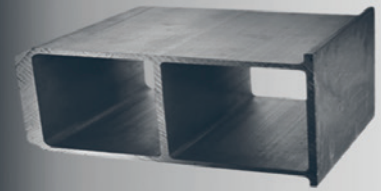
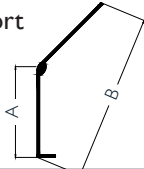
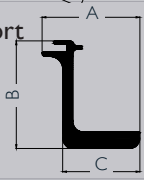

SECTION	EX STOCK	PRODUCT	A	B	C	LENGTH m m	KILO / METRE	PERIMETER m m	ALLOY
60022	*	Transport Frame 	100.0	183.74			1.917	437.0	6060/T5
60140	*	Transport Body 	76.1	83.7	60.1		3.848	331	6060/T5
90042	✓	Planking 	228.0	12.7		6.0m	1.673		6063 /T6



A = Width B = Height T = Thickness R = External Radii

\* Mill runs only, please ask regarding the availability of these

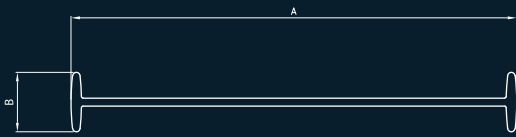
# Other stock lengths available in this size. If the product you require is not listed please enquire

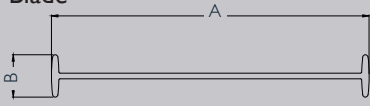
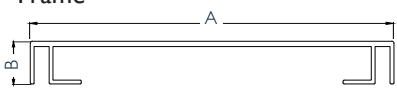
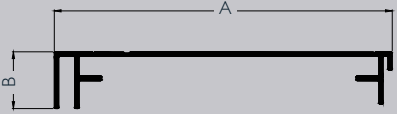
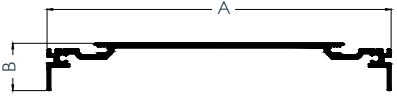
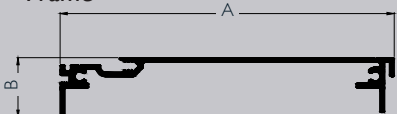

## ALLOY 6060 : 5 METRE LENGTHS

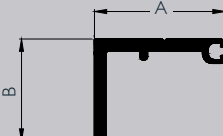
SECTION	EX STOCK	PRODUCT	SIZE		KILO / METRE	PERIMETER
			A	B		
30572	*	Blade 	150.0	20.0	1.375	365.7
31018	✓	Frame 	170.0	20.0	1.619	534.8
60105	*	Frame 	149.0	25.0	1.306	484.0
60106	*	Frame 	182.0	22.0	1.802	556.0
60107	*	Frame 	140.0	25.0	1.295	458.0
60108	*	Frame 	200.0	25.0	2.206	615.0
60109	*	Frame 	32.0	25.0	0.453	131.0

A = Width B = Height T = Thickness R = External Radii

\* Mill runs only, please ask regarding the availability of these

# Other stock lengths available in this size. If the product you require is not listed please enquire